

MANLIFT

MAN LIFTING DEVICES

When you complete this lesson you should:

1. Be familiar with both boom and scissor lifts and their individual uses.
2. Know the safety rules and precautions pertaining to man lifting devices.
3. Be able to perform a visual inspection prior to operating a man lifting device.
4. Be familiar with all the emergency related safety features associated with man lifting devices.
5. Be familiar with the actual operation of a man lifting device.

Man lifting devices are another means of getting workers, equipment, and/or materials to where they are needed on the job. There are two basic kinds of man lifting devices; a scissor lift and a boom lift (see Figure 1). Both scissor and boom lifts offer advantages to the glazier that better enable him to do his job.

SCISSOR LIFTS

A scissor lift work platform has vertical capabilities only (except for Traversing Deck Scissor Lifts). One advantage to using a scissor lift is that it can lift and support a great deal of weight. This can range from a 750 pound capacity on a small platform to 1,500 pounds on a large platform. Scissor lifts generally have a larger work platform than boom lifts and can be used to position both workers and materials to specific work locations.

Scissor lift devices work well for glazing small curtainwall systems (three stories or less). They are also used extensively on the interior of the building in place of scaffolding that would require a great deal of erection time, or, in lieu of a boom lift that would not have the maneuverability of a scissor lift. Where no obstructions are present around the perimeter of the building, the scissor lift can be positioned flush against the wall and raised to the work area. Glazing, caulking and other job functions can be performed from the platform.

Scissor lifts are also available with a traversing deck. Traversing decks are used when an obstruction is present. A traversing deck scissor lift can lift to the height of the work area and then the platform projects over the obstruction to a workable position against the building.

BOOM LIFTS

A boom lift, unlike a scissor lift, has not only vertical movement but also lateral as well. Due to this versatility, a boom lift can get to most of the "hard to reach" areas on a construction site. Some boom lifts are also available with a four wheel drive feature which allows even more maneuverability, especially during icy or muddy conditions. A boom lift is mainly used to get workers to the required working height. They are not made to support large amounts of weight.

Because of the boom lift's capability to extend itself (up to 110 feet), it is not necessary that it be set up directly next to or flush against a building. The boom can be positioned some distance from the desired area and can be extended to the work position. The basket/platform tilts and turns to facilitate a direct frontal access to most work areas. If the boom's required extension exceeds 110 feet, an articulated "super-boom" could be used (see Figure 2).

Always remember prior to using a boom device, to test the controls before getting near a building. Some controls are very "touchy" and you could easily swing into a wall or a lite of glass causing damage or injuries.

SAFETY RULES AND PRECAUTIONS

As with any machinery, strict adherence to all safety rules and precautions is imperative to avoid damage and/or worker injuries. The following precautions are extremely important to the safe operation of any lifting device:

1. Only properly trained and authorized workers are allowed to use man lifting devices. All safety material, such as operation manuals,

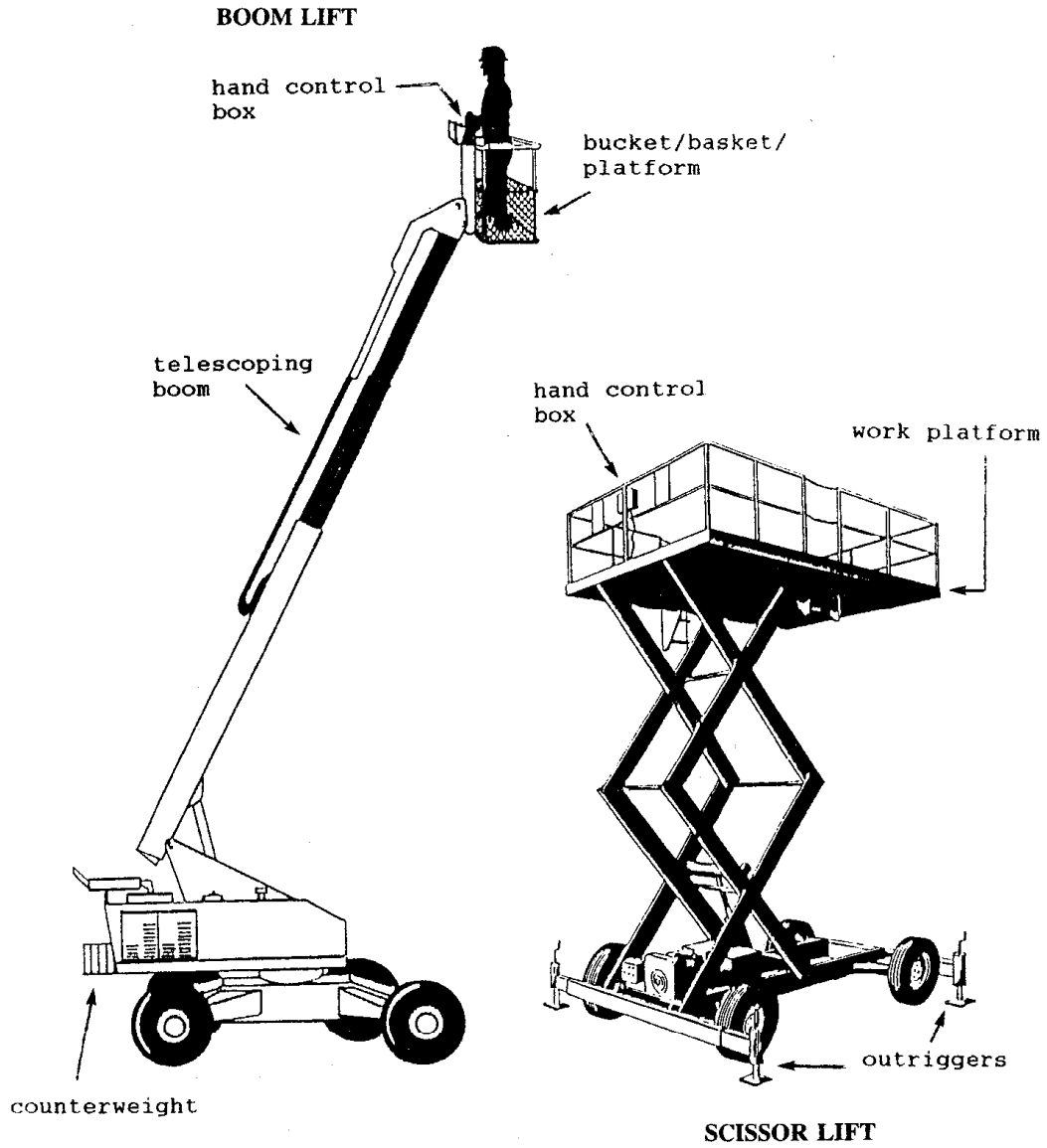
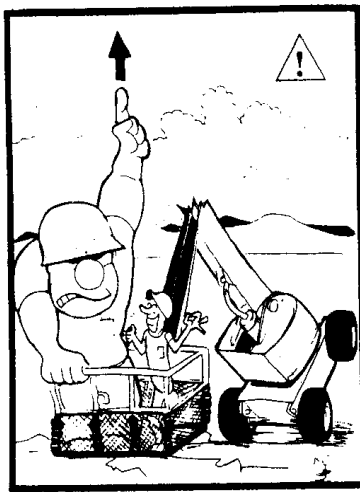

Figure 1

4. All controls must be tested each day prior to their use to be sure that they are in safe operating condition.
5. The lifting device must be set-up on a firm surface and leveled prior to operation to avoid tipping or other serious accident. The supporting surface must be able to support the combined weight of the machinery and the load. Also all outriggers must be securely in place.
6. Man lifting devices should not be driven on uneven, sloping, or soft terrain as it may cause the machine to tip over.
7. The lifting device operator must know the platform load limitations as recommended by the manufacturer. Remember the load capacity includes not only the total weight of all materials but also that of any personnel (Figure 3).



WRONG

KNOW YOUR CAPACITY AND OPERATE WITHIN IT

Figure 3

8. To avoid a potential tipping hazard, all loads must be evenly distributed over the entire surface of the work platform.
9. Lifts must never be used near electrical power lines unless the lines have been de-energized by the local power company. A clearance of at

least 10 feet between any part of the machine or its load and any electrical line or apparatus carrying up to 50,000 volts is required. Approximately one additional foot of clearance is required for every additional 30,000 volts. You must also incorporate into this clearance factor additional space allowing for platform swaying, rocking, or sagging, along with any movement of the electrical line.

10. A safety inspection must be made prior to using any lifting device to be sure it is in safe operating condition. This inspection should be done even if another worker has recently used the machine.
11. If guardrails are removed, they must be put back in place prior to operating the lifting device. The platform rail holding bolts must also be secured at all times. At no time should workers lean out over the platform guard railings.

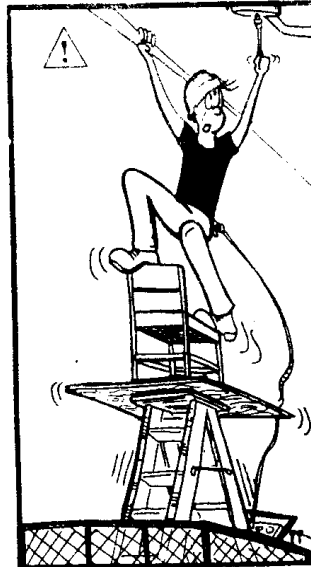

WRONG

ALWAYS STAND FIRMLY ON FLOOR OF PLATFORM. DO NOT SIT OR CLIMB ON EDGE OF PLATFORM, OR USE PLANKS, LADDERS, OR OTHER DEVICES FOR A WORK POSITION.

Figure 4

12. Never use ladders, buckets, or any other apparatus to obtain a greater working height on the platform. All work must be done from the surface of the working platform (see Figure 4).
13. A hard hat must be worn when working on a scissor or boom device. In addition, when working on a boom lift, an approved safety harness with the lanyard attached only to an approved platform attachment point must be worn. Never attach the lanyard to an adjacent pole, equipment, or any other structure to avoid being pulled from your position when the machine moves (see Figure 5).

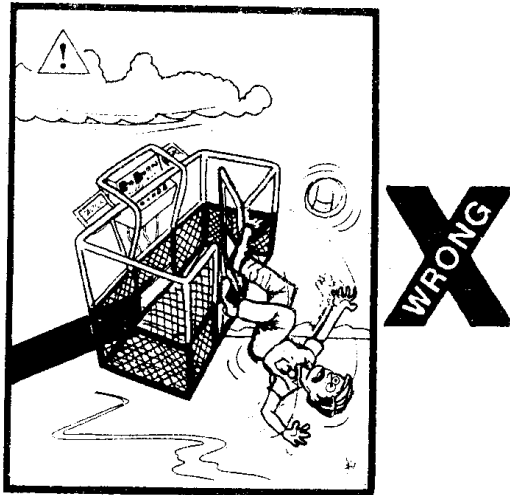

USE SAFETY BELT AND KEEP GATE LATCHED, OR YOU MAY GO DOWN IN HISTORY.

Figure 5

14. Never operate a unit that is not functioning properly.
15. The hand control box must be removed when the machine is not in operation to prevent unauthorized use.
16. The ground-based component box should not be used to operate the platform except in emergency situations or when permission has been granted by the personnel on the platform.
17. The working platform must not be used as a welding ground. Both battery leads must be disconnected prior to performing any welding operations. Normal battery operations can produce flammable hydrogen and oxygen gases. Extreme caution should be used to avoid flames or sparks near the battery vents to avoid explosions.
18. Sulphuric acid from the battery can cause serious burns. Protective face and eye equipment must be worn when checking the condition of the batteries. If you should come in contact with this acid, flush it with clean water and seek immediate medical attention.
19. Do not use the battery from a man lift to jump start other equipment. Jump starting other equipment can seriously reduce the battery's strength rendering it unreliable in crucial situations.
20. The battery must be monitored closely during the charging process to avoid overcharging and boiling. Do not smoke or introduce any flame or spark during charging. Always charge in an open, well-ventilated area.
21. All hydraulic, mechanical, and/or electrical safety components and shut-offs are important safety factors. They must never be overridden or ignored.
22. It is unsafe to work on a man lifting platform if you are sick, dizzy or unsteady. **DO NOT TAKE CHANCES.**
23. The lifting device operator must be familiar with all warning and precautionary decals prior to operation. These warning decals highlight potential hazards and the proper operation and load limitations of the machinery. Failure to comply with these warnings can result in damage to machinery, serious injury, or **DEATH.**
24. The operator of the unit must be familiar with all state, local, and federal safety regulations in connection with the safe operation of any man lifting device.

25. The man lift operator must be alert to all hazards and dangerous situations or conditions to prevent serious injury to himself and others.
26. Do not drive a lifting device in an extended position.
27. When driving or moving the platform, always insure adequate clearance around the lifting device to avoid contact with other structures or hazards. Also be aware of drop-off holes, bumps, trees, shrubbery and floor obstructions (see Figure 6).

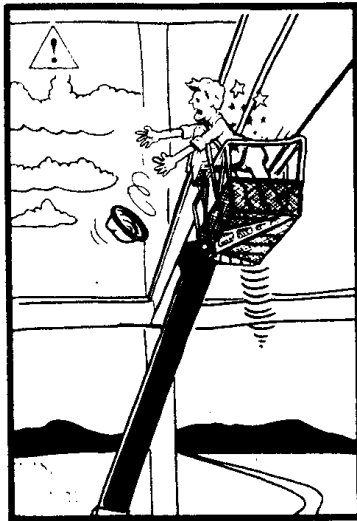

THOROUGHLY CHECK ALL CLEARANCES BEFORE POSITIONING PLATFORM.

Figure 6

28. Always keep ground personnel from under the platform when it is in the elevated position (see Figure 7).
29. When moving the lifting apparatus, do not allow wires, cables, rope or other materials to hang down from the platform.
30. Do not operate a lifting device in bad weather conditions, such as high winds (gust of 25 mph or more), during thunderstorms, etc.

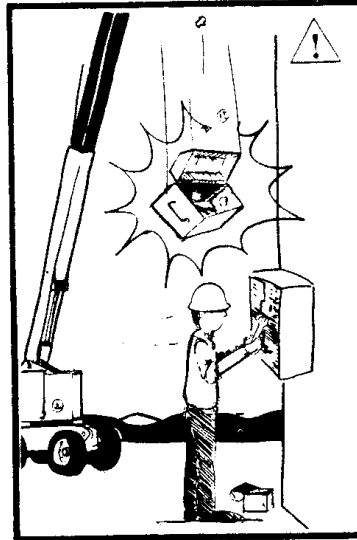

DO NOT OPERATE OVER GROUND PERSONNEL.

Figure 7

31. Do not remove the drive control box cover for any reason unless you are a qualified mechanic. The control box contains high amperage components.
32. Become familiar with all emergency related safety features specifically designed for your machine prior to operation.

PRACTICE PROBLEMS:

1. A scissor lift can support more weight than a boom lift.
 True False
2. What qualifications must a worker have before being allowed to operate a lifting device?
3. Why should all handhold areas be checked on a lifting device prior to operation?

4. Why must all controls be plainly marked?
and the ground controls. These functions would include forward, reverse, left, right, up and down.
5. Why must the load be evenly distributed over the entire surface of the work platform?
2. Check the fluid levels in the hydraulic oil reservoir, batteries, and fuel level.
6. When is it correct for workers to lean out over the guardrails on a platform?
3. Inspect the chassis, the boom, and the working platform for loose or missing parts and/or fasteners, wear, weld cracks, excessive rusting, dents, bends or other signs of damage.
7. When operating a lifting device, all work must be done from _____
4. Check the hydraulic components such as the pump, motor, filter, valves, cylinders, flexible and metal lines and all fittings for leaks.
8. Why must the hand control box be removed when the machine is not in use?
5. Check the tire inflation pressure (on pneumatic tires only). Also check to see that the proper inflation pressure is shown on the tire inflation placard. All tires should be checked for excessive wearing, cuts, or damage.
9. What action must be taken if you come in contact with the sulphuric acid from the battery?
6. Check all wheel lug nuts for any missing or loose nuts. Also torque all loose nuts with a torque wrench to the proper torque amount as indicated on the placards located near each wheel.
10. Why must the battery be monitored closely during charging?
7. Make sure that the batteries have sufficient charge to perform the day's work. Always recharge the batteries after use.
8. Check to see that the brakes are functioning properly. Test them by actuating then releasing the travel controls.
9. Check the wiring cables and harnesses for proper installation and tightness.
10. Check the boom pivot shafts to insure proper lubrication. They must be lubricated after approximately every 10 hours of use to maintain peak efficiency and safety.

VISUAL INSPECTION

Prior to using any man lifting device, a visual inspection and function test must be done to insure that the equipment has been properly maintained and is safe to use. The following specific items should be checked when doing a safety type inspection:

1. The unit must be able to perform basic functions both with the component box controls

EMERGENCY RELATED SAFETY FEATURES

Operating a lifting device can be hazardous. Along with exercising every precaution to prevent injuries, boom and scissor lift units also come equipped with various emergency safety features. Become familiar with the specific features of your machine prior to operation. Some of the safety features are as follows:

Manual Descent Valves (both boom and scissor lifts)

Manual descent valves are hand operated from ground level to retract and lower the lifting device should an emergency occur.

Ground Based Controls (both boom and scissor lifts)

Ground based controls can override the platform controls if an emergency occurs, such as, the operator is unable to control the lifting device from the platform, the platform is in tight quarters, or is in jeopardy of being crushed.

Footswitch (boom lift only)

A foot operated switch is located on the platform and is used to stop the machine if an emergency occurs. The footswitch must be released to start the engine and depressed to operate all controls.

Auxiliary Power (boom lift only)

An auxiliary battery operated hydraulic pump can be operated using either the platform or ground based controls if the primary power source (the gasoline engine, diesel engine, or electricity) fails to function.

High Speed Drive Cut-Out Switch (both boom and scissor lifts)

The high speed drive cut-out switch automatically shuts off the high speed drive when the lift is raised.

Tilt Alarm (boom lift only)

The tilt alarm is a sensing device that lights a light whenever the body of the lifting device is out of level in any direction approximately 5 degrees.

Warning Light (both boom and scissor lifts)

A warning light will light up whenever an unstable condition is present such as a tilt of three degrees or more in any direction. The lifting device will automatically cut-out the lifting circuit interrupting any lifting motion.

OPERATION

To perform the various functions of a man lifting device all instructional material pertinent to the machine must first be reviewed. Again, all signs, placards, and warnings must be precisely followed along with all state, local and/or federal regulations.

Operating a Scissor Lift

A scissor lift can be operated using either a hand control box used by the operator in the platform or a

component box switch panel located at ground level (usually on the side of the machine). Refer to the specific manufacturer's instructions for your machine.

Steering

The steering mechanism for a scissor lift is a control switch located on the hand control box. Pushing the control switch to either the right or left allows the front wheels to go to the right or left. As a safety feature, when the operator releases the switch it automatically returns to the off position.

Raising/Lowering

To raise or lower the platform, the hand control box or the component box can be used. It operates with a momentary switch; push the switch into the up position and the platform raises, push the switch to the down position and the platform lowers. When the momentary switch is released it also automatically returns to the off position.

Travel

The hand control box controls all forward and reverse motions of the scissor lift. Most machines are capable of three speeds in both forward and reverse; low speed, high speed and creep speed. Creep speed can be manually activated or it automatically cuts-in when the platform is raised over one half of its rated height.

Outriggers

Outriggers are commonly used when platform heights exceed 30 feet (see Figure 8). Manual outriggers must be extended individually prior to raising the platform. Manual outriggers can be retracted while the platform is in the extended position however this can cause the unit to tip resulting in serious injuries.

Hydraulic outriggers are either extended or retracted using a control switch found on the hand control box. When hydraulic outriggers are being used the scissor lift's drive system is automatically cut-out to prevent damage to the outriggers. To move the unit from one work area to another the platform should be lowered and the hydraulic outriggers must be retracted.

Brakes

All brakes on scissor lifts are electrical. They are located on the front steering axle. The brakes are designed to hold the lifting device on a level surface

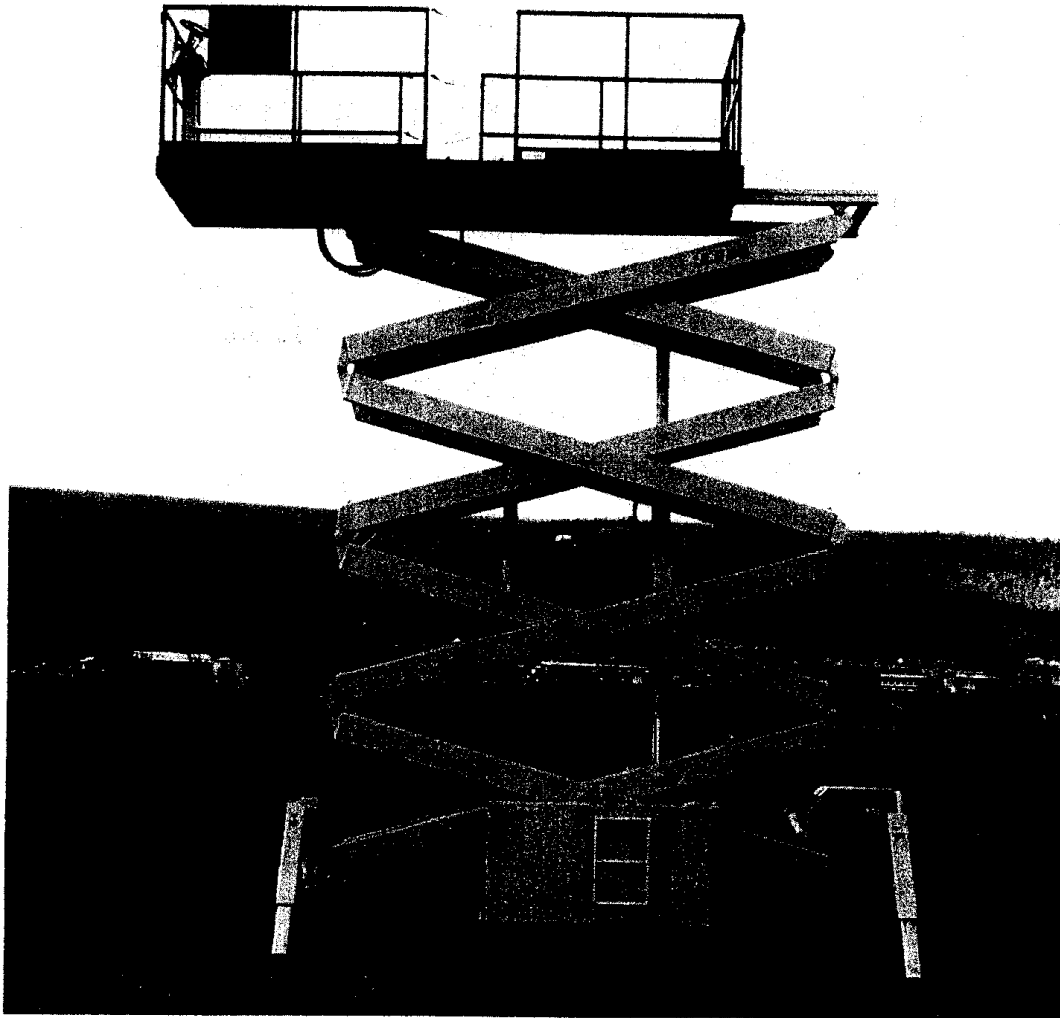

Figure 8
Traversing Deck Scissor Lift with Outriggers
(Extended)

only. The brakes may not hold on an incline greater than 4 degrees.

Tires

To increase platform stability, the tires on some scissor lift devices can be filled with liquid. Each

wheel is equipped with a water fill valve stem as standard equipment. Tire pressure should be maintained at 35 pounds. A calcium chloride solution is recommended to prevent freezing in colder climates.

Operating a Boom Lift

Steering

The steering mechanism on a boom lift varies depending on the position of the boom. In the forward position, depress the footswitch, move the control to the right and the machine moves in that direction, move it left and it moves left. These controls will be reversed when the boom is rotated 180 degrees.

Raising/Lowering/Swinging/Rotating

To raise or lower the boom, depress the footswitch and move the lift control either up or down and hold it until the desired height is reached. To swing the boom, again, depress the footswitch, and then move the swing control slowly to the left or the right and hold it until the platform is positioned properly. The platform rotates when the rotate control switch is moved either to the left or the right. Always move the control levers slowly for a smooth execution.

Travel

If driving must be done with the platform elevated, extreme caution is required. Driving with an elevated platform is not recommended and can be hazardous. Actuate all controls with a slow and even motion to avoid abrupt changes of direction that may cause possible tipping or other accidents. Never use "high" speed in the extended position. Always be aware of clearances between the machine and any adjacent structures or equipment when driving. It is important to post a lookout when the operator's view is obstructed in any way.

Outriggers

If a machine is equipped with outriggers, they are required whenever the boom is to be extended beyond the retracted length or raised above the horizontal. If the outriggers are not properly set-up and in firm contact with the supporting surface the machine may tip over resulting in serious injury or death. Some blocking may be necessary to provide support for the outriggers. Outrigger positioning is done at the ground control station. The area must be clear of all personnel and obstructions before the outrigger beams can be extended. Carefully follow all manufacturer's instructions for outrigger extension and retraction. The outrigger selector switch must be in a "down" position to prevent accidental retraction of the outriggers. Do not retract the outriggers until the

boom is below the horizontal position. Do not move the machine until all outrigger beams and jacks have been completely retracted. Some models may have extendable axles in lieu of outriggers for machine stability. Most boom lifts are equipped with an interlock alarm system. This safety system sounds a siren if the outriggers are not properly positioned or if the boom has rotated a few degrees off center.

Capacity Indicator

Most boom lifts also have a feature called a capacity indicator (see Figure 9). This indicator must be used if the platform load exceeds 500 pounds. Do not operate the machine with a load over 500 pounds if the capacity indicator is damaged or the color coded strips are missing.

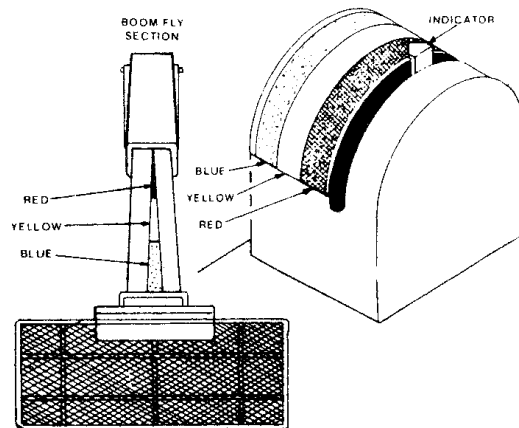

Pendulum Capacity Indicator

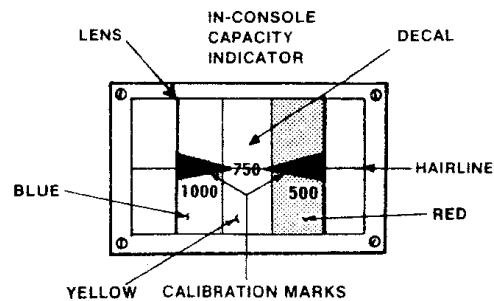

In-Console Capacity Indicator

Figure 9

To use the capacity indicator you must first know the total weight of the load including the weight of all personnel, tools and materials. After the boom is lifted and elevated to the approximate work angle, the capacity indicator can be read and it can be determined at what color range(s) the machine can be safely operated with the known platform load. While monitoring the color strips, extend the boom to the work position. If a color appears on the indicator showing that the platform load is greater than the platform rated capacity, stop immediately and position the machine closer to the work area.

Additional information concerning the load capacity can be found on the decal posted on the machine chassis or from the manufacturer.

MAINTENANCE

Check with the rental agent/manufacturer to establish what steps must be taken to maintain a safe operating machine. Never allow a machine to be used until it has been serviced and maintained according to the manufacturer's specifications and schedule. The following maintenance safety precautions must also be adhered to:

1. Always disconnect the battery when replacing any electrical component.
2. Remove all rings, watches, or other jewelry when performing any maintenance type work. Do not wear loose fitting clothing or leave long hair unrestrained. Serious injuries have occurred when these items become caught or entangled in the equipment.
3. Use only manufacturer's approved nonflammable cleaning solvents on the machines.
4. Shut off all power controls before making any adjustments or performing any other maintenance.
5. Absolutely no smoking is permitted during refueling. Never refuel during electrical storms or near welding operations. Always make sure that the fuel cap is closed after refueling.

PRACTICE PROBLEMS:

11. When would auxiliary power be necessary?
12. What is the purpose of a tilt alarm?
13. On a scissor lift, when is "creep" speed used?
14. Lifting device brakes may not hold on an incline greater than _____ degrees.
15. Why must the outrigger selection switch be in the down position on a boom lift following the extension of all outriggers?



MANLIFT

Danger

Failure to obey the instructions and safety rules in this manual will result in death or serious injury.

Do Not Operate Unless:

- You learn and practice the principles of safe machine operation contained in this operator's manual.
 - 1 Avoid hazardous situations.**
Know and understand the safety rules before going on to the next section.
 - 2** Always perform a pre-operation inspection.
 - 3** Always perform function tests prior to use.
 - 4** Inspect the work place.
 - 5** Only use the machine as it was intended.
- You read, understand and obey:
 - Manufacturer's instructions and safety rules—safety and operator's manuals and machine decals
 - employer's safety rules and worksite regulations
 - applicable governmental regulations
- You are properly trained to safely operate the



Electrocution Hazards

This machine is **not** electrically insulated and will **not** provide protection from contact with or proximity to electrical current.

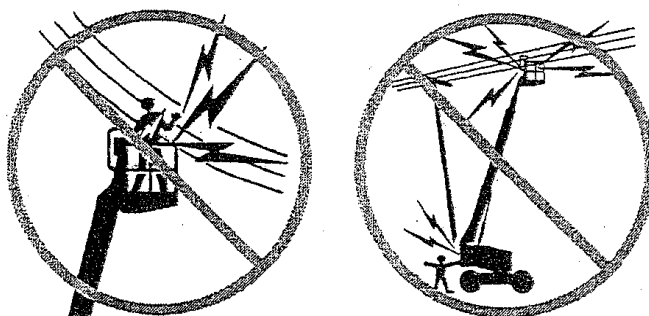

Maintain safe distances from electrical power lines and apparatus in accordance with applicable governmental regulations and the following chart.

Voltage Phase to Phase	Minimum Safe Approach Distance	
	Feet	Meters
0 to 300V	Avoid Contact	
300V to 50KV	10	3.05
50KV to 200KV	15	4.60
200KV to 350KV	20	6.10
350KV to 500KV	25	7.62
500KV to 750KV	35	10.67
750KV to 1000KV	45	13.72

Allow for platform movement, electrical line sway or sag and beware of strong or gusty winds.

Keep away from the machine if it contacts energized power lines. Personnel on the ground or in the platform must not touch or operate the machine until energized power lines are shut off.

Do not operate the machine during lightning or

Tip-over Hazards

Occupants and equipment shall not exceed the maximum platform capacity.

Maximum platform capacity	500 lbs	227 kg
Maximum occupants		2

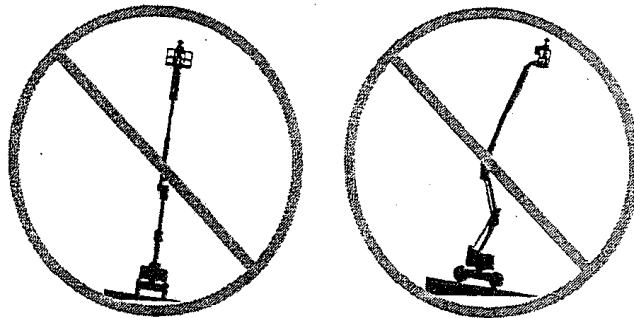

Do not raise or extend the boom unless the machine is on a firm, level surface.

Do not depend on tilt alarm as a level indicator. Tilt alarm sounds in platform only when machine is on a severe slope (4.5° or more).

If tilt alarm sounds:

Do not extend, rotate or raise boom above horizontal. Move machine to a firm, level surface before raising platform. If tilt alarm sounds when platform is raised, use extreme caution to retract boom and lower platform. Do not rotate boom while lowering. Move machine to a firm, level surface before raising platform.

Do not alter or disable the limit switch(s).

Do not drive over 0.6 mph (1 km/h) with the boom raised or extended.

Do not raise the boom in strong or gusty winds.

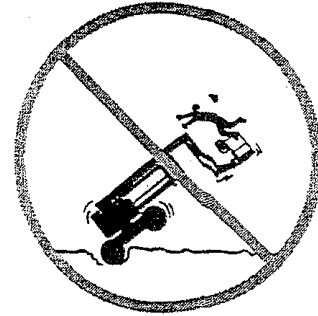

Use extreme care and slow speeds while driving the machine in stowed position across uneven terrain, debris, unstable or slippery surfaces and near holes and drop-offs.

Do not drive the machine on or near uneven terrain, unstable surfaces or other hazardous conditions with the boom raised or extended.

Do not push off or pull toward any object outside of the platform.

Maximum allowable side force	150 lbs 667 N
-------------------------------------	------------------

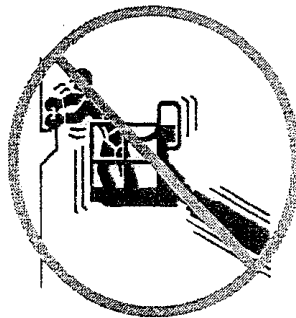

Do not alter or disable machine components that in any way affect safety and stability.

Do not replace items critical to machine stability with items of different weight or specification.



Do not place or attach overhanging loads to any part of this machine.

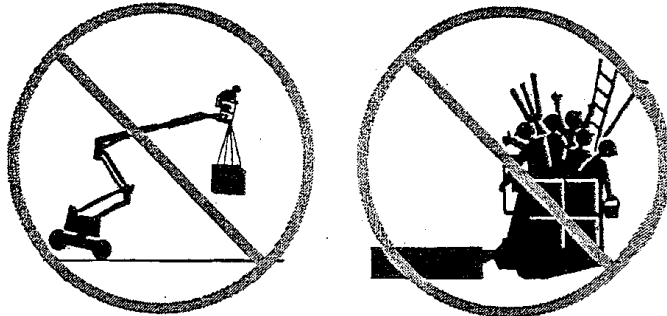

Do not place ladders or scaffolds in platform or against any part of this machine.

Do not use machine on a moving or mobile surface or vehicle.

Be sure all tires are in good condition and lug nuts are properly tightened.

Do not use batteries that weigh less than the original equipment. Batteries are used as counterweight and are critical to machine stability. Each battery must weigh 110 pounds (49.9 kg). Each battery box including 4 batteries must weigh a minimum of 538 pounds (244 kg).

Do not use the machine as a crane.

Do not push the machine or other objects with the boom.

Do not contact adjacent structures with the boom.

Do not tie the boom or platform to adjacent structures.

Do not place loads outside the platform perimeter.

Fall Hazards

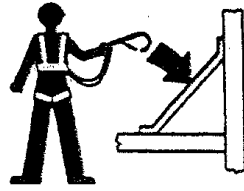

Occupants must wear a safety belt or harness and comply with applicable governmental regulations. Attach lanyard to anchor provided in platform.

Do not sit, stand or climb on the platform guard rails. Maintain a firm footing on the platform floor at all times.

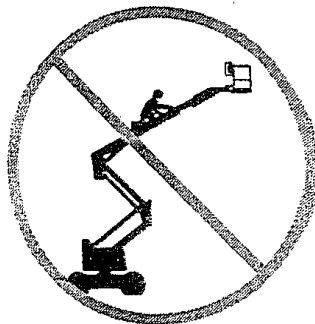

Do not climb down from the platform when raised.

Keep the platform floor clear of debris.

Lower the platform entry mid-rail or close the entry gate before operating.

Collision Hazards

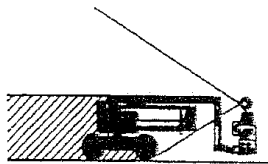

Be aware of limited sight distance and blind spots when driving or operating.

Be aware of boom position when rotating turntable.

Machine must be on level surface or secured before releasing brakes.

Do not drive the machine with the remote brake system released. If the travel alarm sounds when not driving, the remote brake system is released.

Check work area for overhead obstructions or other possible hazards.

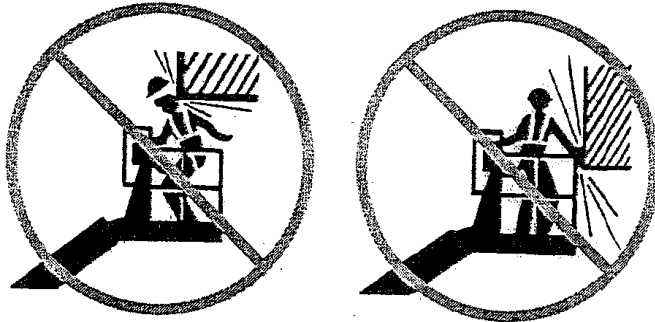

Be aware of crushing hazard when grasping the platform guard rail.

It is recommended that operators wear an approved hard hat when operating the machine.

Observe and use color-coded direction arrows on the platform controls and drive chassis for drive and steer functions.

Do not lower the boom unless the area below is clear of personnel and obstructions.

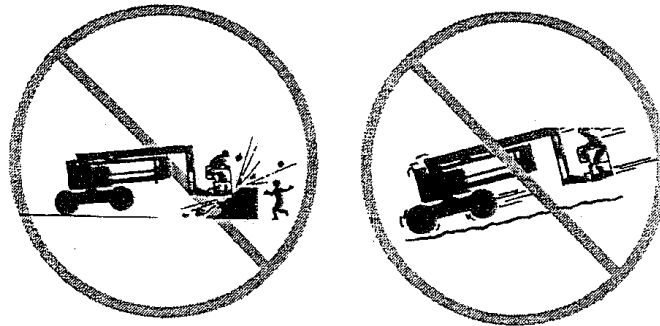

Limit travel speed according to condition of ground surface, congestion, slope, location of personnel, and any other factors which may cause collision.

Do not operate a boom in the path of any crane unless the controls of the crane have been locked out and/or precautions have been taken to prevent any potential collision.



Component Damage Hazard

Do not use machine as a ground for welding.

Damaged Machine Hazards

Do not use a damaged or malfunctioning machine.

Conduct a thorough pre-operation inspection of the machine and test all functions before each work shift. Immediately tag and remove from service a damaged or malfunctioning machine.

Be sure all maintenance has been performed as specified in this manual and the *Genie Z-34/22 & Genie Z-34/22N Service Manual*.

Be sure all decals are in place and legible.

Be sure safety and operator's manuals are complete, legible and in the storage container located on the platform.

Decal Legend

Genie product decals use color coding and signal words to identify the following:

▲ DANGER Red—used to indicate the presence of a hazard that **will** cause death or serious injury.

▲ WARNING Orange—used to indicate the presence of a hazard that **may** cause death or serious injury.

▲ CAUTION Yellow—used to indicate the presence of a hazard that **will** or **may** cause serious injury or damage to the machine.

NOTE Green—used to indicate operation or maintenance information.

Battery Safety

Burn Hazards

Batteries contain acid. Always wear protective clothing and eyewear when working with batteries.



Avoid spilling or contacting battery acid. Neutralize battery acid spills with baking soda and water.

Battery pack must remain in upright position.

Do not expose the batteries or the charger to water and/or rain.

Explosion Hazards



Keep sparks, flames and lighted tobacco away from batteries. Batteries emit an explosive gas.

The battery pack cover must remain off during the entire charging cycle.

Do not contact the battery terminals or the cable clamps with tools that may cause sparks.

Component Damage Hazards

Do not use any battery charger greater than 48V to charge the batteries.

Both battery packs must be charged together.

Disconnect the battery pack plug before removing the battery pack.

Electrocution Hazards



Connect the battery charger to a grounded, AC 3-wire electrical outlet only.

Inspect daily for damaged cord, cables and wires. Replace damaged items before operating.

Avoid electrical shock from contact with battery terminals. Remove all rings, watches and other jewelry.

Tip-over Hazard

Do not use batteries that weigh less than the original equipment. Batteries are used as counterweight and are critical to machine stability. Each battery must weigh 110 pounds (49.9 kg). Each battery box including batteries must weigh a minimum of 538 pounds (244 kg).

Lifting Hazard

Use a forklift to remove or install the battery pack(s).

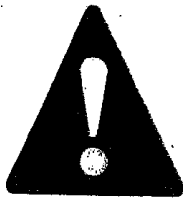

Do Not Operate Unless:

You learn and practice the principles of safe machine operation contained in this operator's manual.

1 Avoid hazardous situations.

2 Always perform a pre-operation inspection.

Know and understand the pre-operation inspection before going on to the next section.

3 Always perform function tests prior to use.

4 Inspect the work place.

5 Only use the machine as it was intended.

Fundamentals

It is the responsibility of the operator to perform a Pre-operation Inspection.

The Pre-operation Inspection is a visual inspection performed by the operator prior to each work shift. The inspection is designed to discover if anything is apparently wrong with a machine before the operator performs the function tests.

Refer to the list on page 10 and check each of the items and locations for modifications, damage or loose or missing parts.

A damaged or modified machine must never be used. If damage or any variation from factory delivered condition is discovered, the machine must be tagged and removed from service.

Repairs to the machine may only be made by a qualified service technician, according to the manufacturer's specifications. After repairs are completed, the operator must perform a pre-operation inspection again before going on to the function tests.

Scheduled maintenance inspections shall be performed by qualified service technicians, according to the manufacturer's specifications and the requirements listed in the responsibilities manuals.



Pre-operation Inspection

- Be sure that the operator's, safety and responsibilities manuals are legible and in the storage container located on the platform.
- Be sure that all decals are legible and in place (see Decals, page 18).
- Check the hydraulic power unit oil level. Check for leaks.

Check the following components or areas for damage, modifications and improperly installed or missing parts:

- Electrical components, wiring and electrical cables
- Hydraulic power unit, reservoir, hoses, fittings, cylinders and manifolds
- Drive and turntable motors and torque hubs
- Boom wear pads
- Tires and wheels
- Limit switches, alarms and horn
- Nuts, bolts and other fasteners
- Platform entry mid-rail/gate
- Beacon and alarms (if equipped)

Check entire machine for:

- Cracks in welds or structural components
- Dents or damage to machine
- Be sure that all structural and other critical components are present and all associated fasteners and pins are in place and properly tightened.
- Be sure that both battery packs are in place, latched and properly connected.
- After you complete your inspection, be sure that all compartment covers are in place and

Starting the Engine

- 1 At the ground controls, turn the key switch to the desired position.
- 2 Be sure both ground and platform control red Emergency Stop buttons are pulled out to the ON position.
- 3 Gasoline/LPG models: Choose fuel by moving the fuel select switch to the desired position.
- 4 Move the engine start toggle switch to either side. If engine fails to start or dies, the restart delay will disable the start switch for 8 seconds.

If engine fails to start after 15 seconds of cranking, determine cause and repair any malfunction. Wait 60 seconds before trying to start again.

All models: In extreme cold conditions, 20°F (-6°C) and below, warm engine for 5 minutes to prevent hydraulic system damage.

Gasoline/LPG models: In extreme cold conditions, 20°F (-6°C) and below, machine should be started on gasoline, then switched to LPG.

Emergency Stop

Push in either ground or platform red Emergency Stop button to the OFF position to stop all functions and turn engine off.

Repair any function that operates when the Emergency Stop button is pushed in.

Selecting and operating the ground controls will override the platform Emergency Stop button.

Engine Idle Select (rpm)

Select engine idle (rpm) using the symbols on the control panel.



- Rabbit and foot switch symbol: foot switch activated high idle
- Turtle symbol: low idle
- Rabbit symbol: high idle

Stopping the Engine

Push in the red Emergency Stop button and turn the key switch to the OFF position.

After Each Use

1. Select a safe parking location—firm level surface, clear of obstruction and traffic.
2. Retract and lower the boom to the stowed position.
3. Rotate the turntable so that the boom is between the non-steering wheels.
4. Turn the key switch to the OFF position and remove the key to secure from unauthorized use.
5. Chock the wheels.



Do Not Operate Unless:

- You learn and practice the principles of safe machine operation contained in this operator's manual.

1 Avoid hazardous situations.

2 Always perform a pre-operation inspection.

3 Always perform function tests prior to use.

Know and understand the function tests before going on to the next section.

4 Inspect the work place.

5 Only use the machine as it was intended.

Fundamentals

The Function Tests are designed to discover any malfunctions before the machine is put into service. The operator must follow the step-by-step instructions to test all machine functions.

A malfunctioning machine must never be used. If malfunctions are discovered, the machine must be tagged and removed from service. Repairs to the machine may only be made by a qualified service technician, according to the manufacturer's specifications.

After repairs are completed, the operator must perform a pre-operation inspection and function tests again before putting the machine into service.

17



- 1 Select a test area that is firm, level and free of obstruction.

At the Ground Controls

- 2 Turn the key switch to ground control.
 - 3 Pull out the red Emergency Stop button to the ON position.
- ⊙ Result: Beacon (if equipped) should flash.

Test Emergency Stop

- 4 Push in the red Emergency Stop button to the OFF position.
- ⊙ Result: All ground and platform control functions should not operate.
- 5 Pull out the red Emergency Stop button to the ON position.

Test the Boom Functions

- 6 Activate each boom and platform function toggle switch.
- ⊙ Result: All boom and platform functions should operate through a full cycle. The descent alarm (if equipped) should sound while boom is lowering.

Test the Tilt Sensor

- 7 Pull out the platform red Emergency Stop button to the ON position. Turn the key switch to platform control.
 - 8 Open the ground control side turntable cover and locate the tilt sensor next to the function manifold.
 - 9 Press down one side of the tilt sensor.
- ⊙ Result: The alarm, located in the platform, should sound.

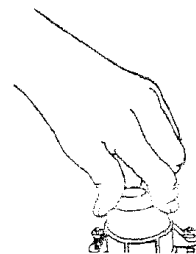

Test Auxiliary Controls

- 10 Turn the key switch to ground control.
- 11 Lift the red auxiliary power switch cover.
- 12 Simultaneously hold the auxiliary power switch on and activate each boom function toggle switch.

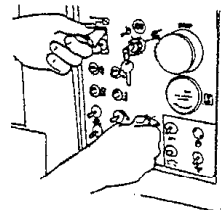

Note: To conserve battery power, test each function through a partial cycle.

- ⊙ Result: All boom functions should operate.
- 13 Turn the key switch to platform control.

At the Platform Controls

Test Emergency Stop

- 14 Push in the platform red Emergency Stop button to the OFF position.

- ⊙ Result: All platform control functions should not operate.

Test the Service Horn

- 15 Pull out the red Emergency Stop button to the ON position.

- 16 Push the service horn button.

- ⊙ Result: The service horn should sound.

Test the Foot Switch

- 17 Do not press down the foot switch. Activate each machine function.

- ⊙ Result: The machine functions should not operate.

Test Machine Functions

- 18 Press down the foot switch.

- 19 Activate each machine function control handle or toggle switch.

Note: Control the speed of boom functions by adjusting the boom function speed controller. Drive and steer functions are not affected by the boom function speed controller.

Test the Steering

20 Press down the foot switch.

21 Depress the thumb rocker switch on top of the drive control handle in the direction identified by the blue triangle on the control panel.

⊙ Result: The steer wheels should turn in the direction that the blue triangles point on the drive chassis.

22 Depress the thumb rocker switch in the direction identified by the yellow triangle on the control panel.

⊙ Result: Steer wheels should turn in the direction that the yellow triangles point on the drive chassis.

Test Drive and Braking

23 Press down the foot switch.

24 Slowly move the drive control handle in the direction indicated by the blue arrow on the control panel until the machine begins to move, then return the handle to the center position.

⊙ Result: The travel/brake release alarm should sound. The machine should move in the direction that the blue arrow points on the drive chassis, then come to an abrupt stop.

25 Slowly move the drive control handle in the direction indicated by the yellow arrow on the control panel until the machine begins to move, then return the handle to the center position.

⊙ Result: The travel/brake release alarm should sound. The machine should move in the direction that the yellow arrow points on the drive chassis, then come to an abrupt stop.

Note: The drive brakes must be able to hold the machine on any slope it is able to climb.

Test Auxiliary Controls

- 10 Turn the key switch to ground control.
- 11 Lift the red auxiliary power switch cover.
- 12 Simultaneously hold the auxiliary power switch on and activate each boom function toggle switch.

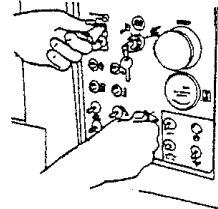

Note: To conserve battery power, test each function through a partial cycle.

- ⊙ Result: All boom functions should operate.
- 13 Turn the key switch to platform control.

At the Platform Controls

Test Emergency Stop

- 14 Push in the platform red Emergency Stop button to the OFF position.

- ⊙ Result: All platform control functions should not operate.

Test the Service Horn

- 15 Pull out the red Emergency Stop button to the ON position.

- 16 Push the service horn button.

- ⊙ Result: The service horn should sound.

Test the Foot Switch

- 17 Do not press down the foot switch. Activate each machine function.

- ⊙ Result: The machine functions should not operate.

Test Machine Functions

- 18 Press down the foot switch.

- 19 Activate each machine function control handle or toggle switch.

Note: Control the speed of boom functions by adjusting the boom function speed controller. Drive and steer functions are not affected by the boom function speed controller.

Test the Steering

- 20 Press down the foot switch.
- 21 Depress the thumb rocker switch on top of the drive control handle in the direction identified by the blue triangle on the control panel.
- ⊙ Result: The steer wheels should turn in the direction that the blue triangles point on the drive chassis.
- 22 Depress the thumb rocker switch in the direction identified by the yellow triangle on the control panel.
- ⊙ Result: Steer wheels should turn in the direction that the yellow triangles point on the drive chassis.

Test Drive and Braking

- 23 Press down the foot switch.
- 24 Slowly move the drive control handle in the direction indicated by the blue arrow on the control panel until the machine begins to move, then return the handle to the center position.
- ⊙ Result: The travel/brake release alarm should sound. The machine should move in the direction that the blue arrow points on the drive chassis, then come to an abrupt stop.
- 25 Slowly move the drive control handle in the direction indicated by the yellow arrow on the control panel until the machine begins to move, then return the handle to the center position.
- ⊙ Result: The travel/brake release alarm should sound. The machine should move in the direction that the yellow arrow points on the drive chassis, then come to an abrupt stop.

Note: The drive brakes must be able to hold the machine on any slope it is able to climb.

Test Limited Drive Speed

- 26 Press down the foot switch.
- 27 Raise the primary boom 1 foot (30 cm).
- 28 Slowly move the drive control handle to the full drive position.
- ⊙ Result: The maximum achievable drive speed with the boom raised should not exceed 1 foot per second (0.3 meters per second).
- 29 Lower the boom to the stowed position.
- 30 Extend the boom 1 foot (30 cm).
- 31 Slowly move the drive control handle to the full drive position.
- ⊙ Result: The maximum achievable drive speed with the boom extended should not exceed 1 foot per second (0.3 meters per second).

If the drive speed with the boom raised or extended exceeds 1 foot per second (0.3 meters per second), immediately tag and remove the machine from service.

Test the Drive Enable System

- 32 Press down the foot switch. Then retract the primary boom to the stowed position.
- 33 Rotate the turntable until the boom moves past one of the non-steering wheels.
- ⊙ Result: The drive enable indicator light should come on and remain on while the boom is anywhere in the range shown.

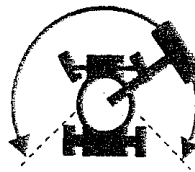

- 34 Move the drive control handle off center.
- ⊙ Result: The drive function should **not** operate.



- 35 Move and hold the drive enable toggle switch up or down and slowly move the drive control handle off center.

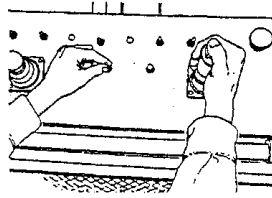

- ⊙ Result: The drive function should operate.

Note: When the drive enable system is in use, the machine may drive in the opposite direction that the drive and steer control handle is moved.

Use the color-coded direction arrows on the platform controls and the drive chassis to identify the direction of travel.

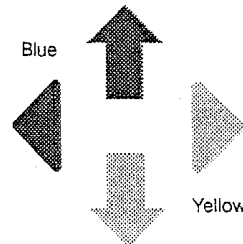

Test Auxiliary Controls

- 36 Press down the foot switch.

- 37 Lift the red auxiliary power switch cover.

- 38 Simultaneously hold auxiliary power switch on and activate each function control handle or toggle switch.

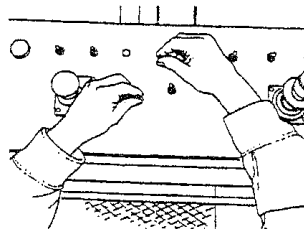

Note: To conserve battery power, test each function through a partial cycle.

- ⊙ Result: All boom, steer and drive functions should operate.

- 39 Repair any malfunctions before operating the machine.



Work Place Inspection



Do Not Operate Unless:

- You learn and practice the principles of safe machine operation contained in this operator's manual.

1 Avoid hazardous situations.

2 Always perform a pre-operation inspection.

3 Always perform function tests prior to use.

4 Inspect the work place.

Know and understand the work place inspection before going on to the next section.

5 Only use the machine as it was intended.

Fundamentals

The Work Place Inspection helps the operator determine if the work place is suitable for safe machine operation. It should be performed by the operator prior to moving the machine to the work place.

It is the operator's responsibility to read and remember the work place hazards, then watch for and avoid them while moving, setting up and operating the machine.



Work Place Inspection

Be aware of and avoid the following hazardous situations:

- drop-offs or holes
- bumps, floor obstructions or debris
- overhead obstructions and high voltage conductors
- hazardous locations
- inadequate surface support to withstand all load forces imposed by the machine
- wind and weather conditions
- the presence of unauthorized personnel
- other possible unsafe conditions



Do Not Operate Unless:

- You learn and practice the principles of safe machine operation contained in this operator's manual.
 - 1 Avoid hazardous situations.
 - 2 Always perform a pre-operation inspection.
 - 3 Always perform function tests prior to use.
 - 4 Inspect the work place.
 - 5 **Only use the machine as it was intended.**

Fundamentals

The Operating Instructions section provides instructions for each aspect of machine operation. It is the operator's responsibility to follow all the safety rules and instructions in the operator's, safety and responsibilities manuals.

Using the machine for anything other than lifting personnel and tools to an aerial work site is unsafe and dangerous.

Only trained and authorized personnel should be permitted to operate a machine. If more than one operator is expected to use a machine at different times in the same work shift, they must all be qualified operators and are all expected to follow all safety rules and instructions in the operator's, safety and responsibilities manuals. That means every new operator should perform a pre-operation inspection, function tests, and a work place inspection before using the machine.

Emergency Stop

Push in the red Emergency Stop button to the OFF position to stop all ground and platform control functions.

Repair any function that operates from the ground or platform controls when the Emergency Stop button at the ground controls is pushed in.

Repair any function that operates from the platform when the Emergency Stop button at the platform controls is pushed in.

Selecting and operating the ground controls will override the platform Emergency Stop button.

Auxiliary Controls

Use auxiliary power if the primary power source fails.

- 1 Turn the key switch to ground or platform control.
- 2 Pull out the red Emergency Stop button to the ON position.
- 3 Press down the foot switch when operating the auxiliary controls from the platform.
- 4 Simultaneously hold auxiliary power switch ON and activate desired function.

The boom, steer and drive functions will operate with auxiliary power.

Operation from Ground

- 1 Turn the key switch to ground control.
- 2 Pull out the red Emergency Stop button to the ON position.
- 3 Be sure both battery packs are connected



Observe and Obey:

- Common sense and planning must be applied to control the movement of the machine when lifting it with a crane or forklift.
- Transport vehicle must be parked on a level surface.
- Transport vehicle must be secured to prevent rolling while machine is being loaded.
- Be sure vehicle capacity, loading surfaces and chains or straps are sufficient to withstand machine weight (see *Specifications*, page 21).
- Machine must be on level surface or secured before releasing brakes.

Securing to Truck or Trailer for Transit

Always chock machine wheels in preparation for transport.

Use tie points on drive chassis for anchoring down to transport surface.

Use lower platform mount between boom end and platform to secure boom from side-to-side movement. Do not use excessive downward force when securing boom section.

Use chains or straps of ample load capacity.

Turn key switch to the OFF position and remove key before transporting.

Inspect entire machine for loose or unsecured items.

